

CPP 440c

45 x 45

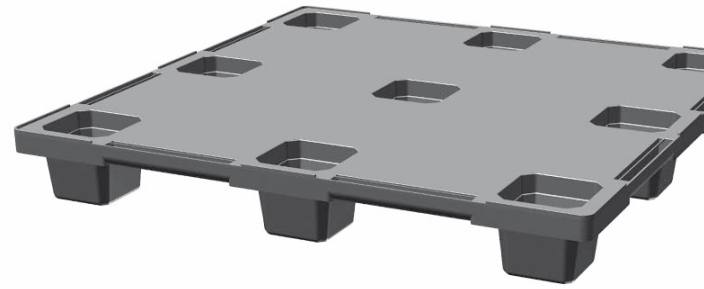

*Nestable container plastic pallet
45" x 45" with closed deck*

Technical Data

Dimensions* ¹	45.0 x 45.0 x 5.5 in	1140 x 1140 x 140 mm
Weight* ¹	ACM 30.0 lbs PE 27.5 lbs	ACM 13.5 kg PE 12.5 kg
Load capacities* ²		
Static	8800 lbs	4000 kg
Dynamic	1700 - 3300 lbs	750 - 1500 kg
Racking	—	—
Bottom support	9 feet	
Entry	4-way	
Safety rim	0.2 in optional	5 mm optional
Nesting height	without skids 2.4 in	60 mm

*¹ The pallet dimensions and weight are variable. *² Guideline values are based both on experience and parts of test ISO 8611, which tests with evenly distributed loads at room temperature (20°C). Varying data may result from different conditions of usage. Your specific requirements can be identified upon request. *³ Minimum quantity required. - We reserve the right to change any of the stated information without prior notice.

Options

Material	Color
ACM, recycled material	black
PE, recycled material	black
PE, virgin material	grey

Individual marking*³
Custom-made color (only virgin material)*³

Perforated top deck - see CPP 440
Snap-on cruciform perimeter-base - see CPP 406

Features

- > Cost effective
- > Extraordinary weight-to-load capacity ratio
- > Reduces freight costs by volume:
29 pallets = 6 feet height
- > Optimal container utilisation, no waste of cargo space
- > Resistant to insects, bacteria and fungi
- > Conforms to ISPM 15 regulation
- > Environmentally friendly product of 100% recycled plastic, completely recyclable

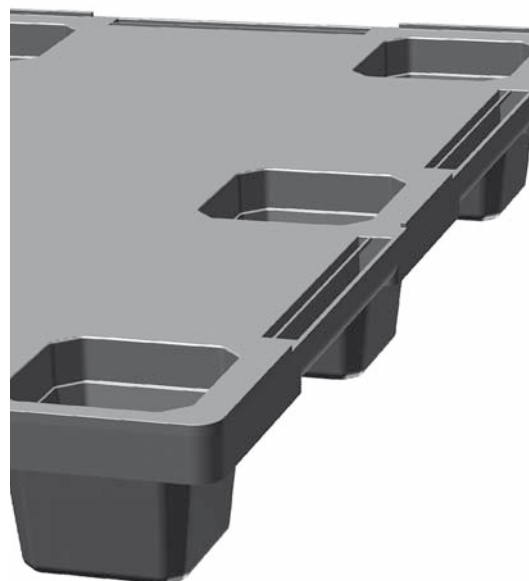
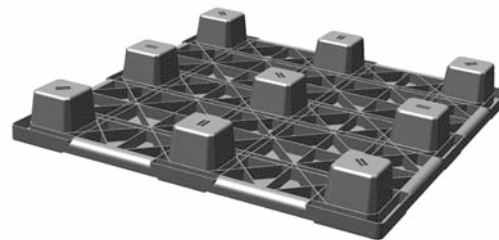

The closed deck prevents dry bulk goods from trickling through and causes less pressure marks on the cargo.



CABKA

The Nelson Company

phone +1410.477.3000, x. 118

fax +1410.477.3577

e-mail service@nelsoncompany.com

www.nelsoncompany.com

CPP 440c

45 x 45

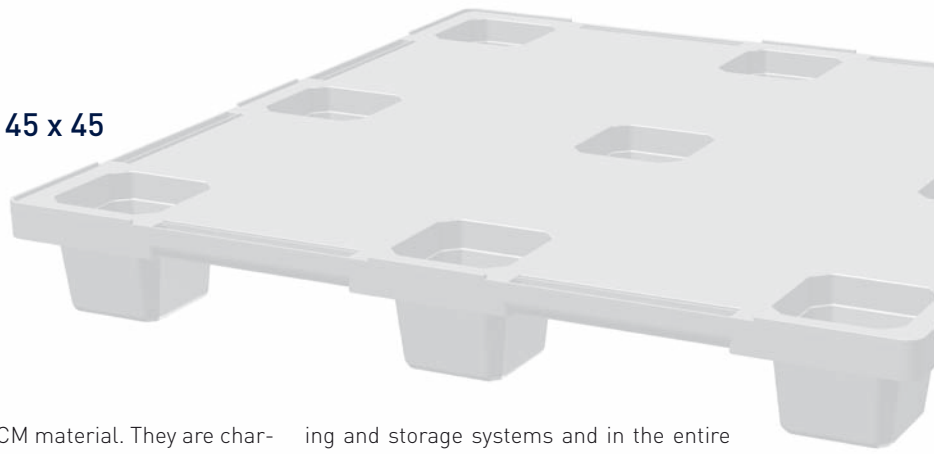

CPP Plastic Pallets

Export pallets

Our Send & Forget™ export pallets enable us to offer a solution to export-oriented companies which is both economically efficient and environmentally friendly. Increasingly integrated international commodity flows call for plastic pallets which provide a high added value to customers while meeting high environmental standards more than ever before.

Our export pallets are made using a spe-

cific recycled ACM material. They are characterized by their lightweight design and by their particularly advantageous price. Obviously, nobody would want to invest a high amount of money in load carriers especially when exporting goods.

Logistic pallets

Our logistic pallets are sturdy long-life storage aids which have stood the test in high-bay warehouses, automated convey-

ing and storage systems and in the entire field of distribution logistics. Achieving a high number of cycles is the key to cost efficiency in this area.

Depending on the needs of every application, CABKA logistics pallets are manufactured using either type-specific PE recycled material or virgin material. In most cases, our recycled plastic material will provide an alternative which is both economically efficient and environmentally sound.

Technical Drawing

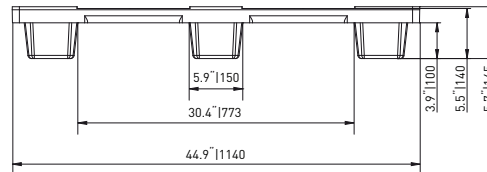
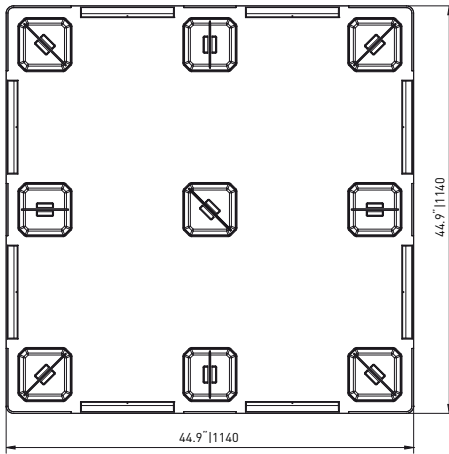

nominal sizes in inches/mm



www.cabka.com